

For reference only. See data sheet for the detailed specifications.

Technical Specification

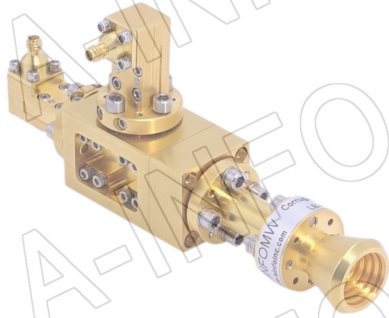

Frequency Range(GHz)	A Type, WG output: 54.0 – 71.0
	C Type, 1.0mm-F: 54.0 – 71.0
	C Type, 1.85mm-F: 54.0 – 65.0
Waveguide	WR15
Gain(dBi)	15 Typ.
Polarization	Dual Linear
3dB Beamwidth(deg)	E Plane: 31 Typ.
	H Plane: 31 Typ.
Cross Pol. Isolation(dB)	40 Typ.
Port to Port Isolation(dB)	45 Typ. ; 35 Min.
VSWR	A Type: 1.5:1 Typ.
	C Type: 2.0:1 Typ.
Output	A Type: FUGP620(UG-385/U)
	C Type: 1.0mm-Female or 1.85mm-Female
Material	Cu
Finish	Gold Plated
Size(mm)	A Type: 20.3 x 20.3 x 82.7
	C Type: 25.6 x 45.7 x 108.1
Net Weight(Kg)	A Type: 0.15 Around
	C Type: 0.20 Around

Outline Drawing (Size: mm)

FUGP620 Output (P/N: LB-CH-15-15-T16-A)

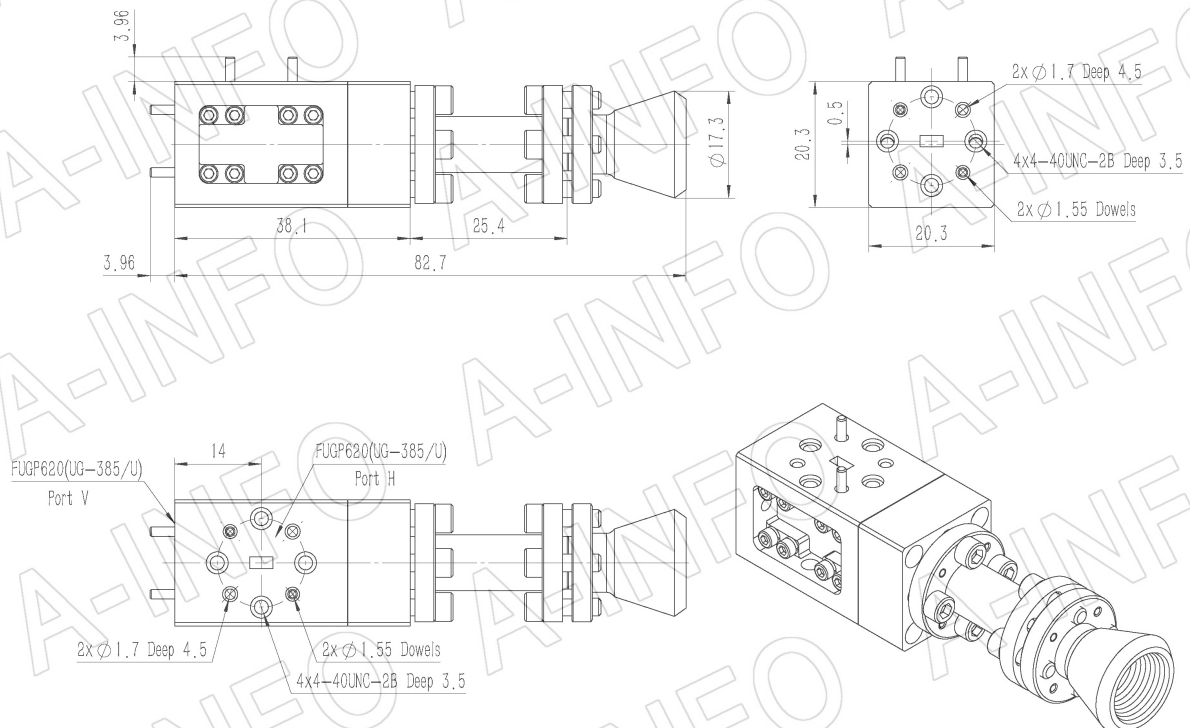

AINFO Inc.

China(Beijing): Tel: (+86) 10-6266-7326,
China(Chengdu): Tel: (+86) 28-8519-2786,
USA : Tel: (+1) 949-639-9688,

Page 1 of 13

(+86) 10-6266-7327 Fax: (+86) 10-6266-7379
(+86) 28-8519-3044 Fax: (+86) 28-8519-3068
(+1) 949-639-9608 Fax: (+1) 949-639-9670

Website: www.ainfoinc.com
Email: sales@ainfoinc.com

1.0mm-Female Output (P/N: LB-CH-15-15-T16-C-1.0F)

For 1.85mm-Female output outline drawing, please contact A-INFO.

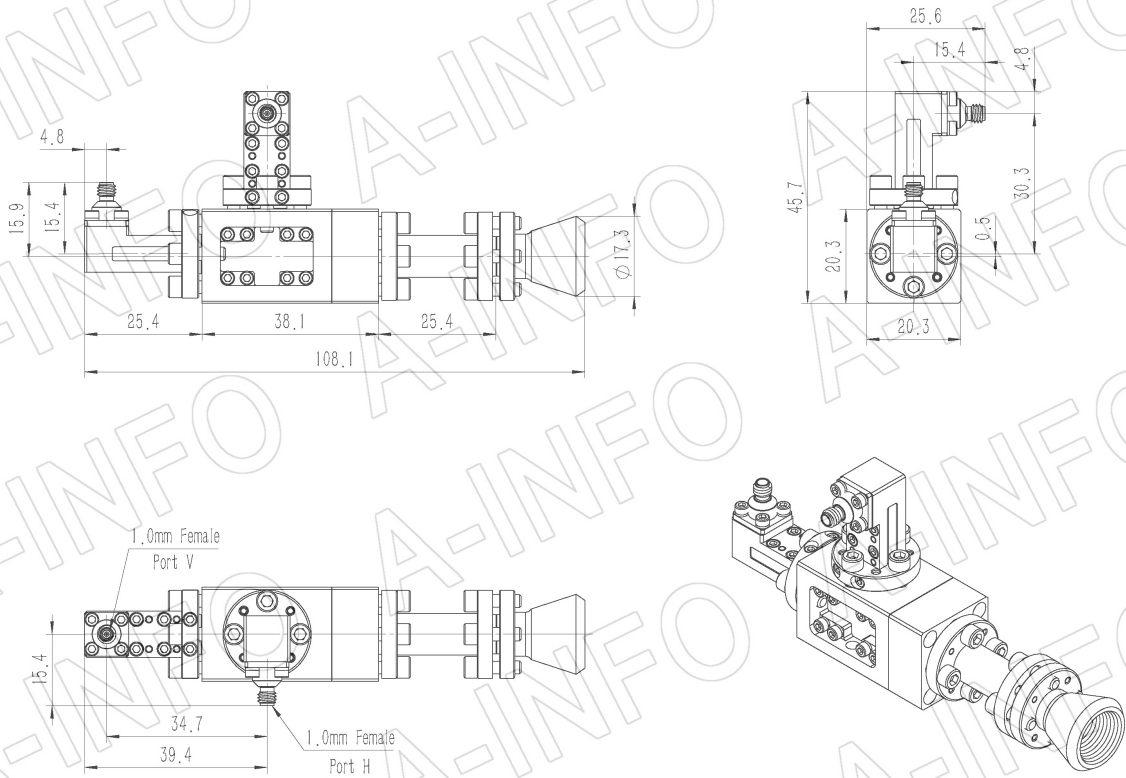

1.0mm-Female Output with Round Mounting Bracket (Option, P/N: LB-CNH-15-15-MB)

For 1.85mm-Female output outline drawing, please contact A-INFO.

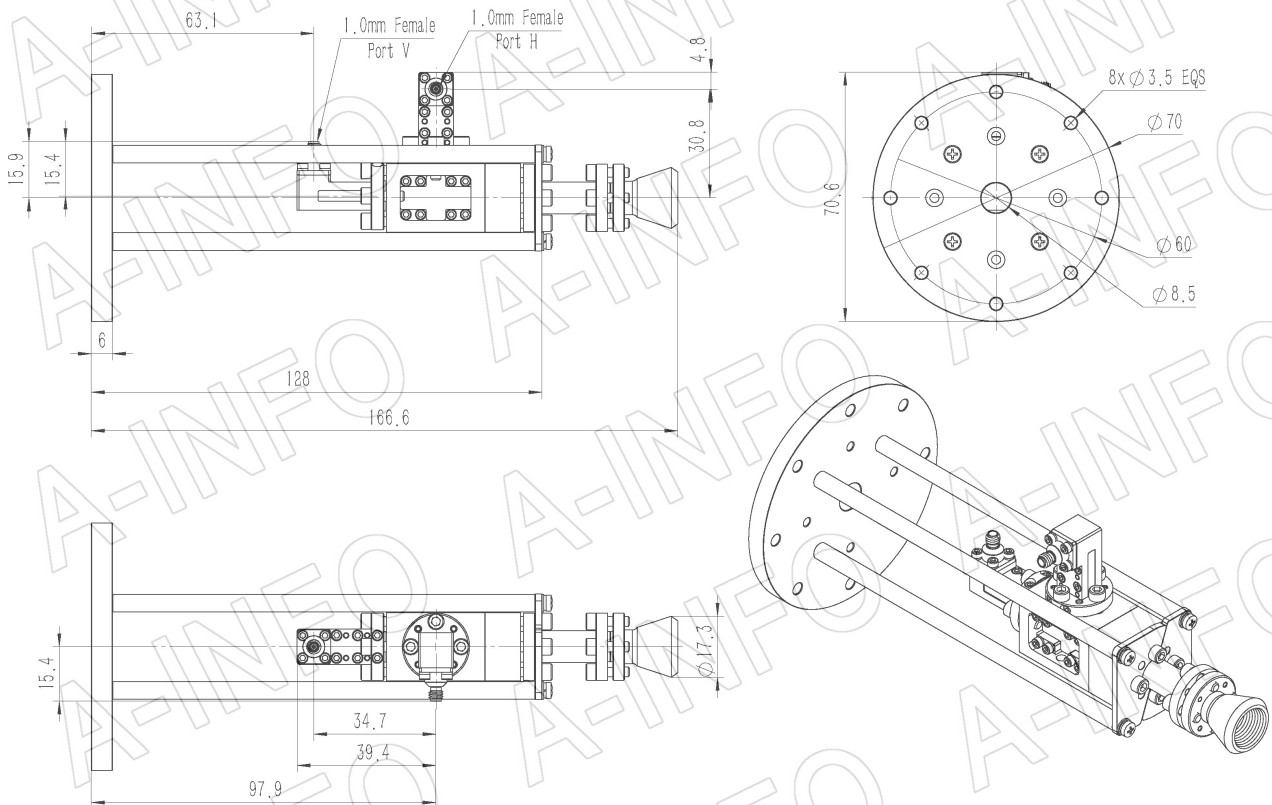

1.0mm-Female Output with L Type Mounting Bracket (Option, P/N: LB-CNH-15-15-MBL)

For 1.85mm-Female output outline drawing, please contact A-INFO.

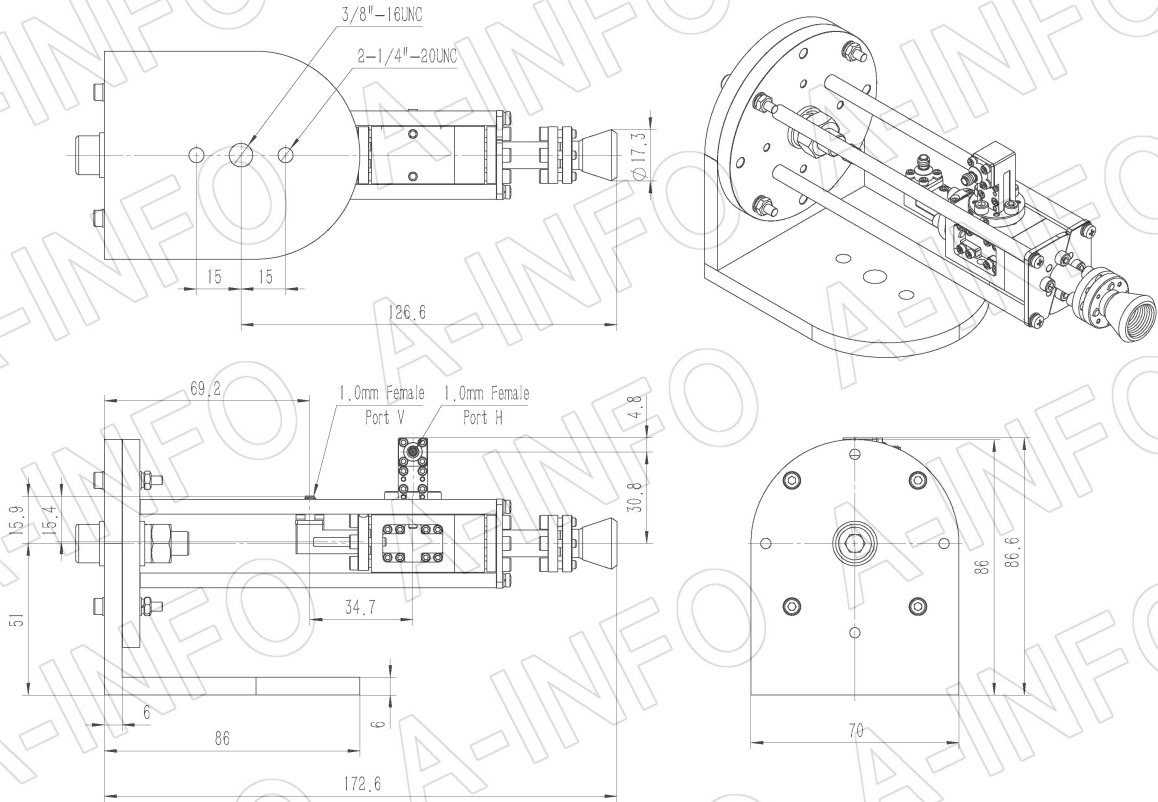

Flange Drawing (Size: mm)

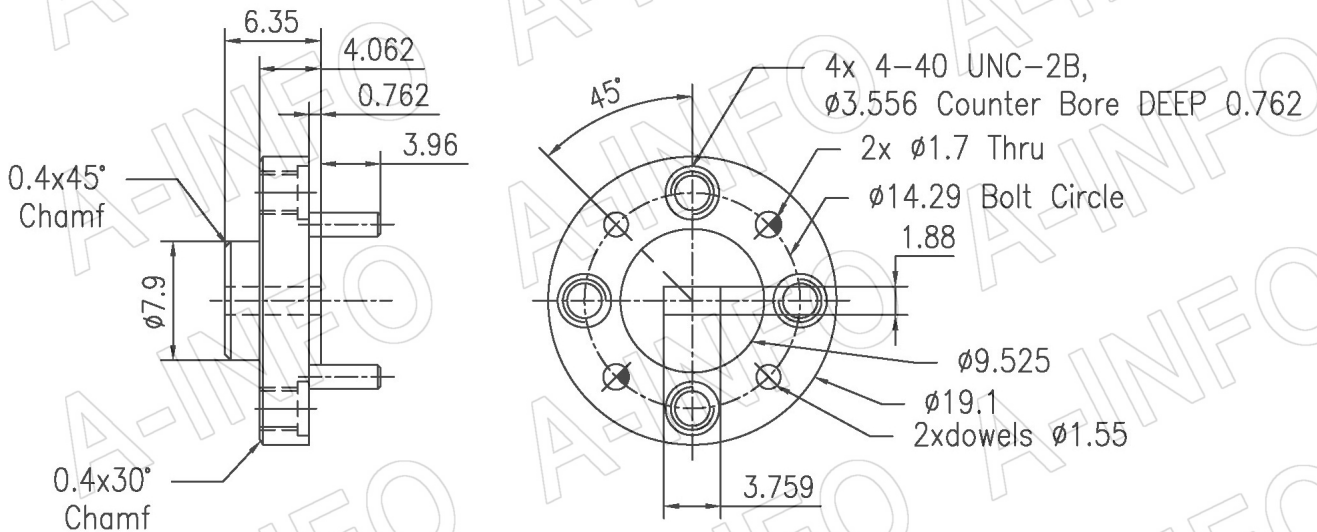

FUGP620
(equivalent to UG-385/U)

AINFO Inc.

China(Beijing): Tel: (+86) 10-6266-7326,
China(Chengdu): Tel: (+86) 28-8519-2786,
USA: Tel: (+1) 949-639-9688,

Page 3 of 13
(+86) 10-6266-7327 Fax: (+86) 10-6266-7379
(+86) 28-8519-3044 Fax: (+86) 28-8519-3068
(+1) 949-639-9608 Fax: (+1) 949-639-9670

Website: www.ainfoinc.com
Email: sales@ainfoinc.com

Test Results

1. Gain & Antenna Factor

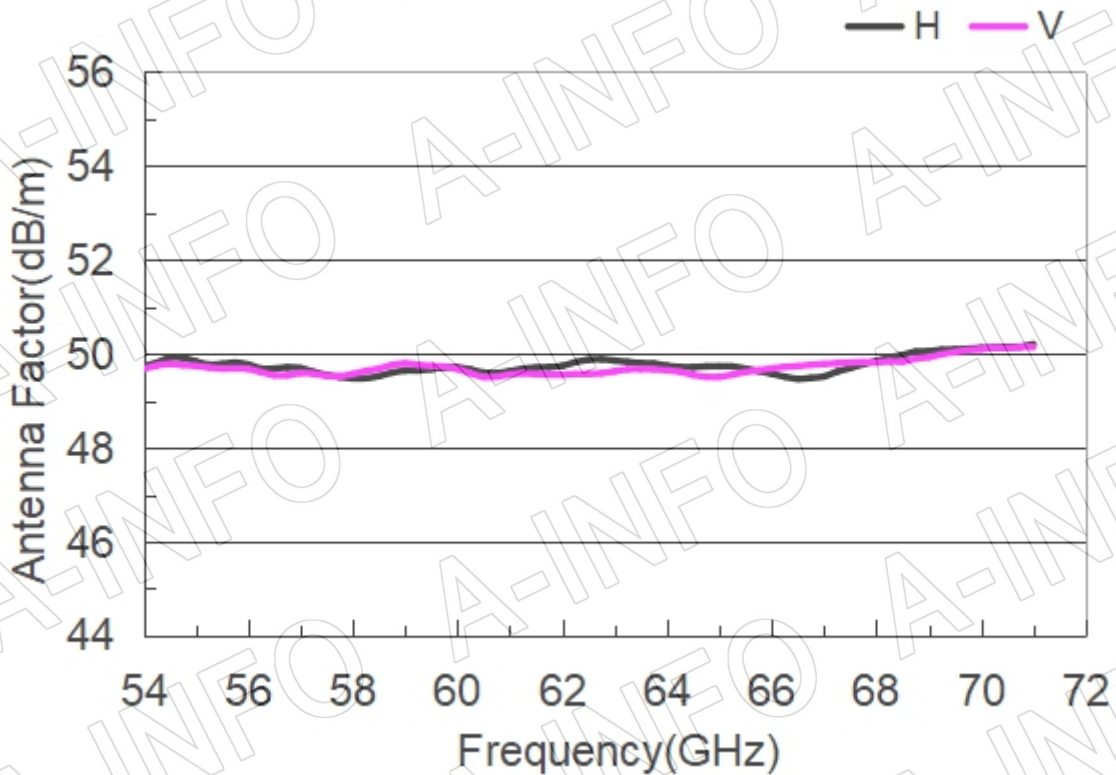
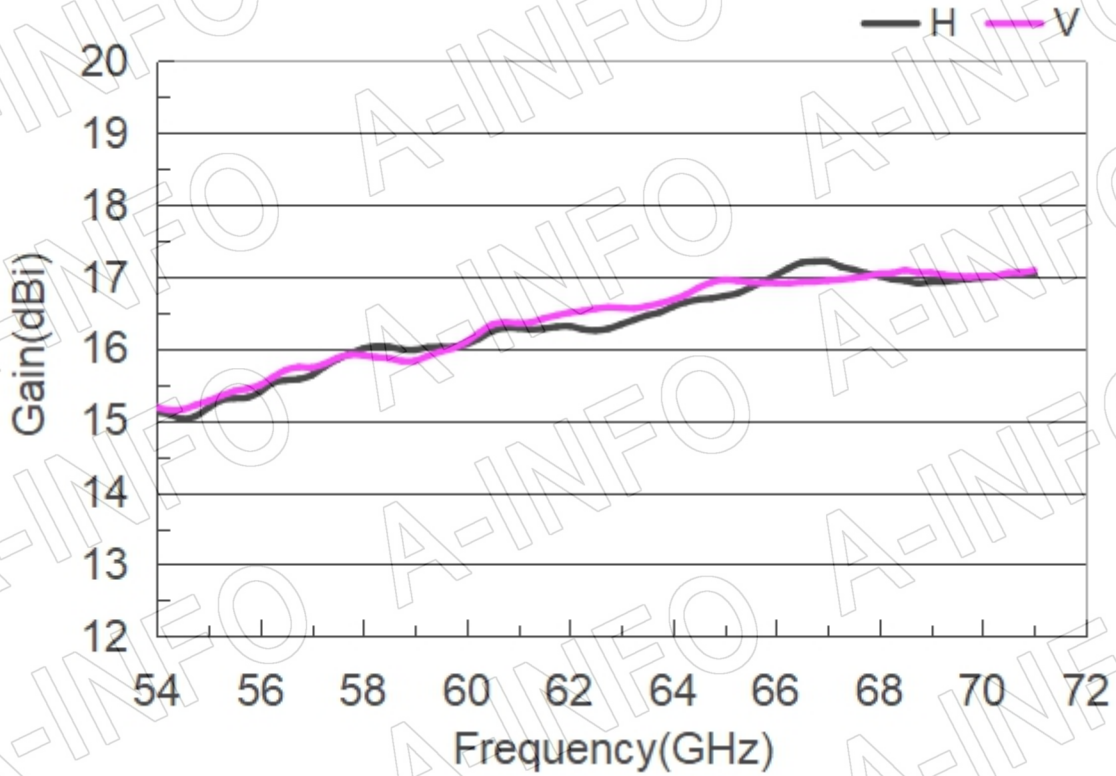

2. Cross Polarization Isolation

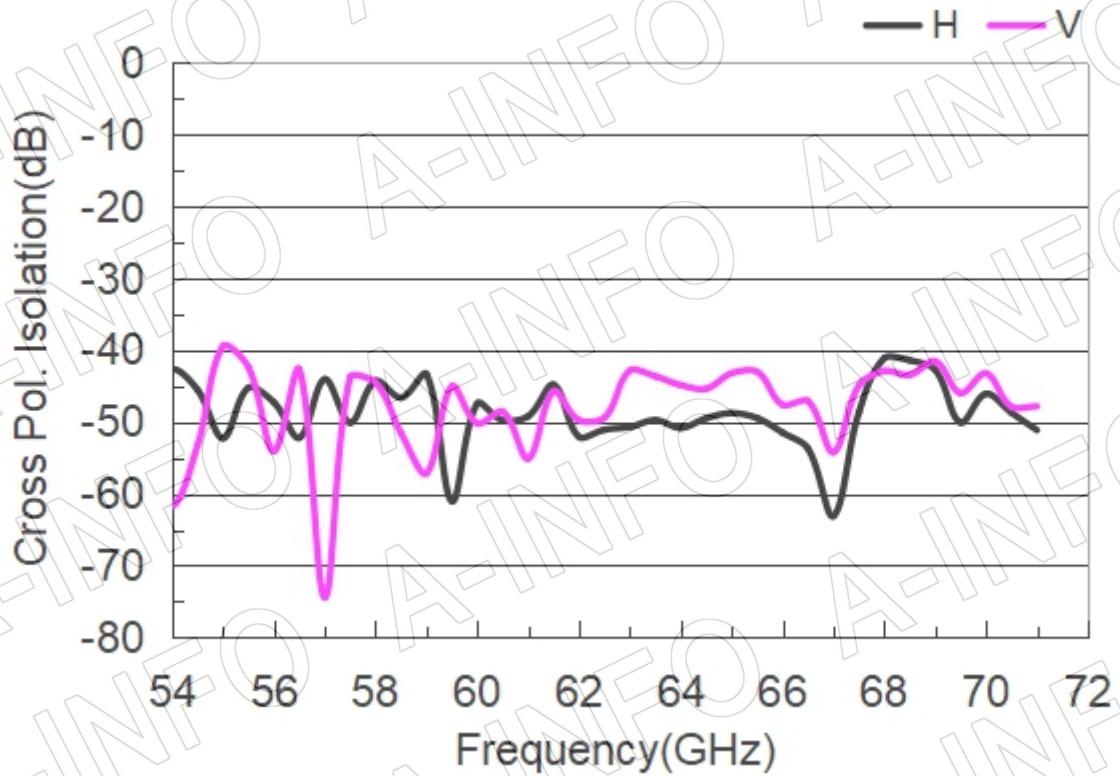

3. Port to Port Isolation

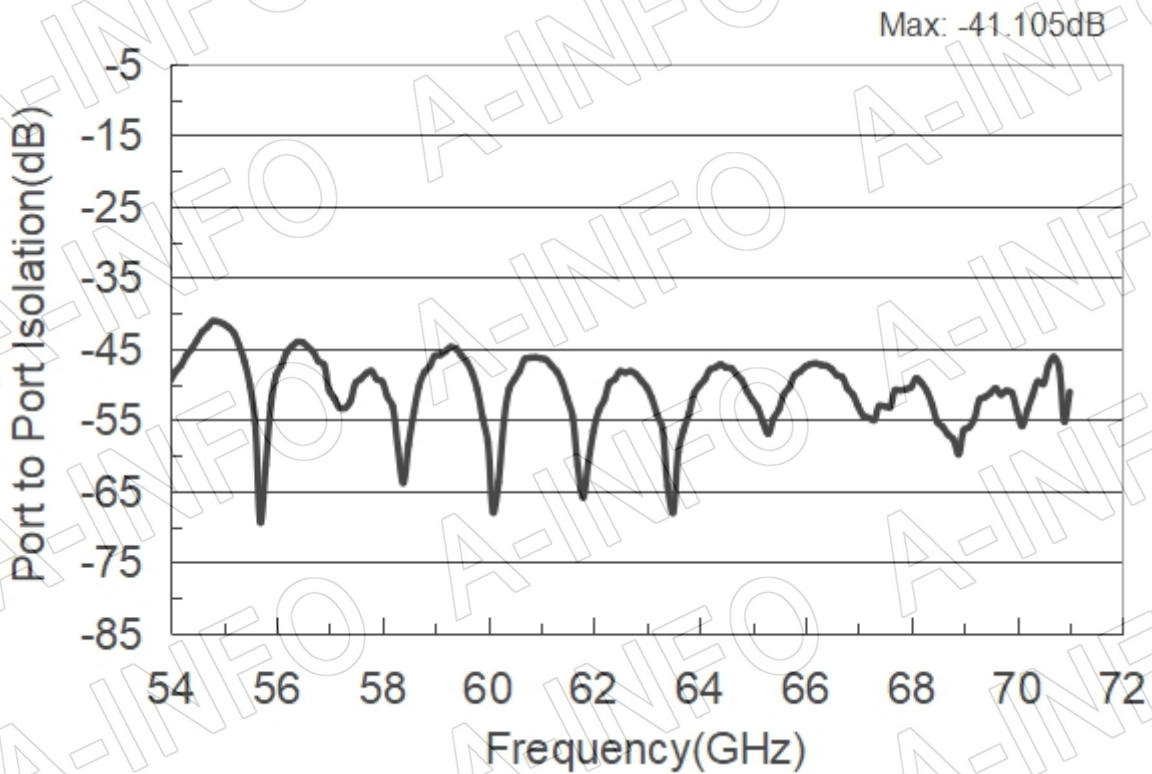

4. VSWR_A Type Port-H

Max: 1.709

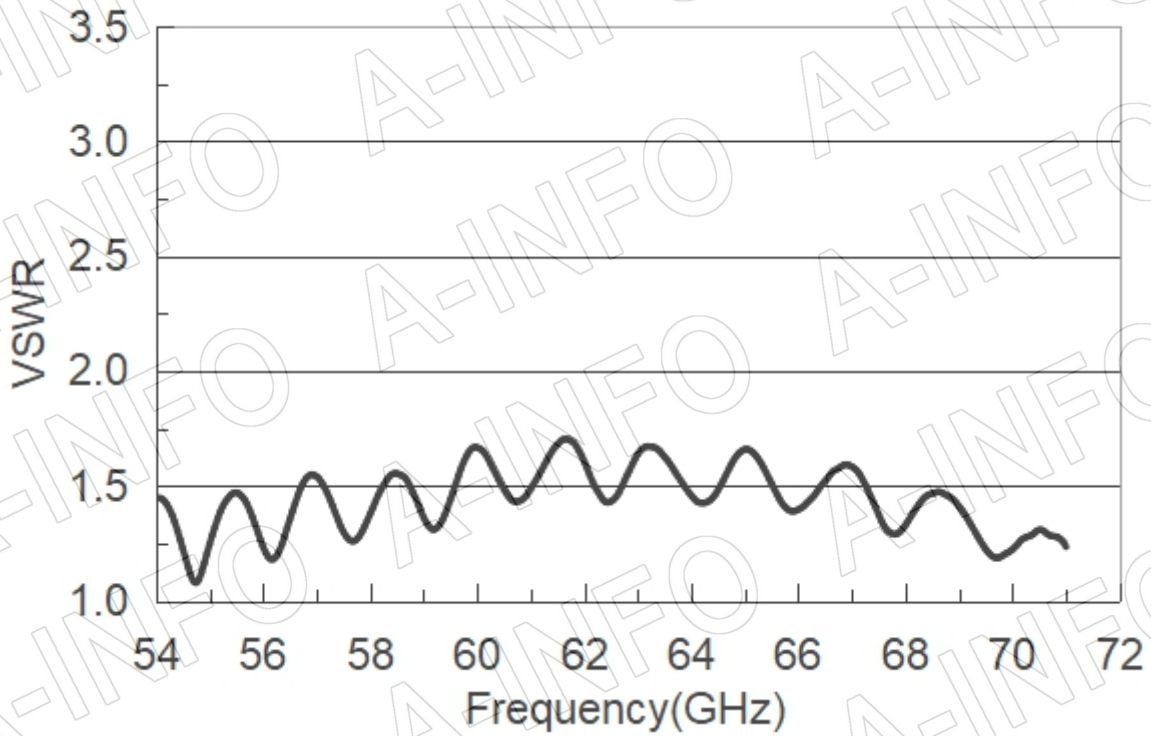

Port-V

Max: 1.643

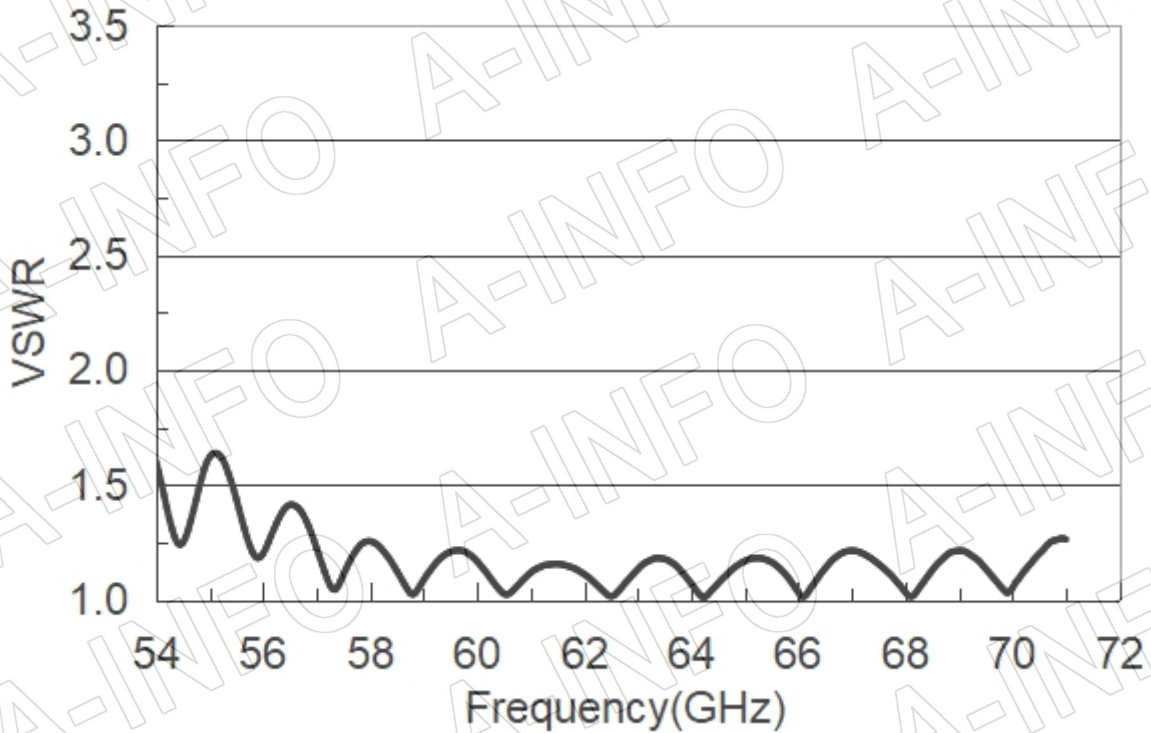

VSWR_C Type
Port-H

Max: 2.001

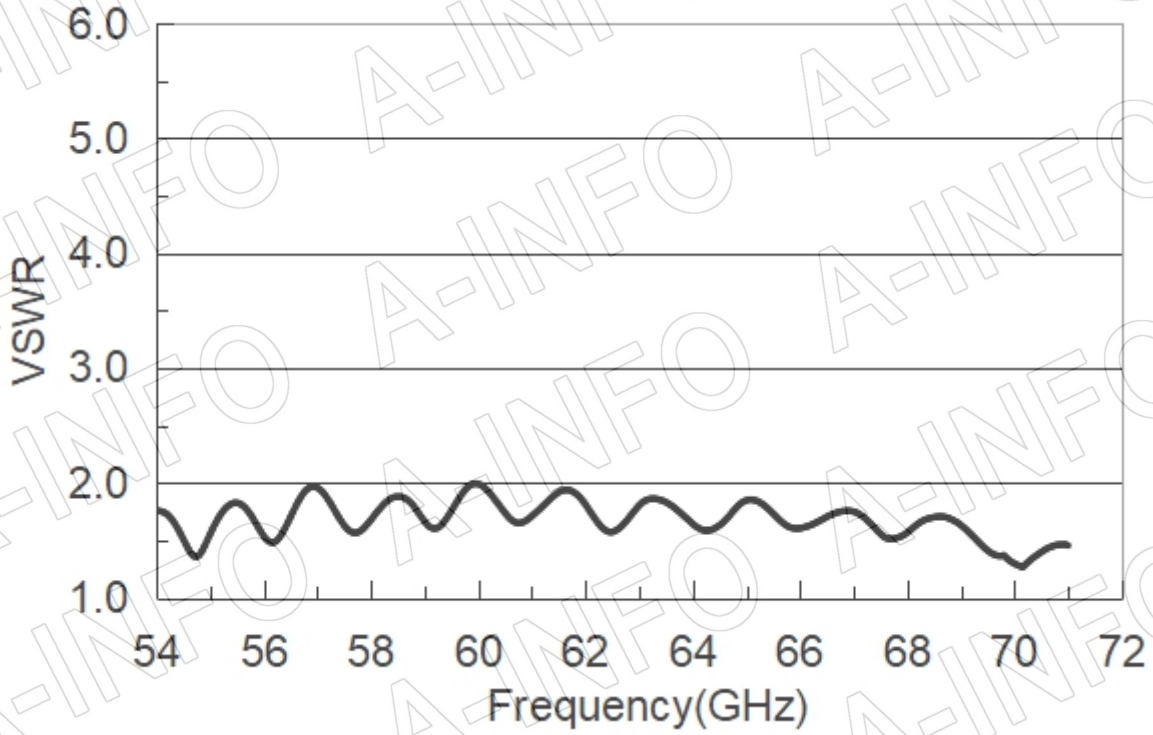

Port-V

Max: 2.050

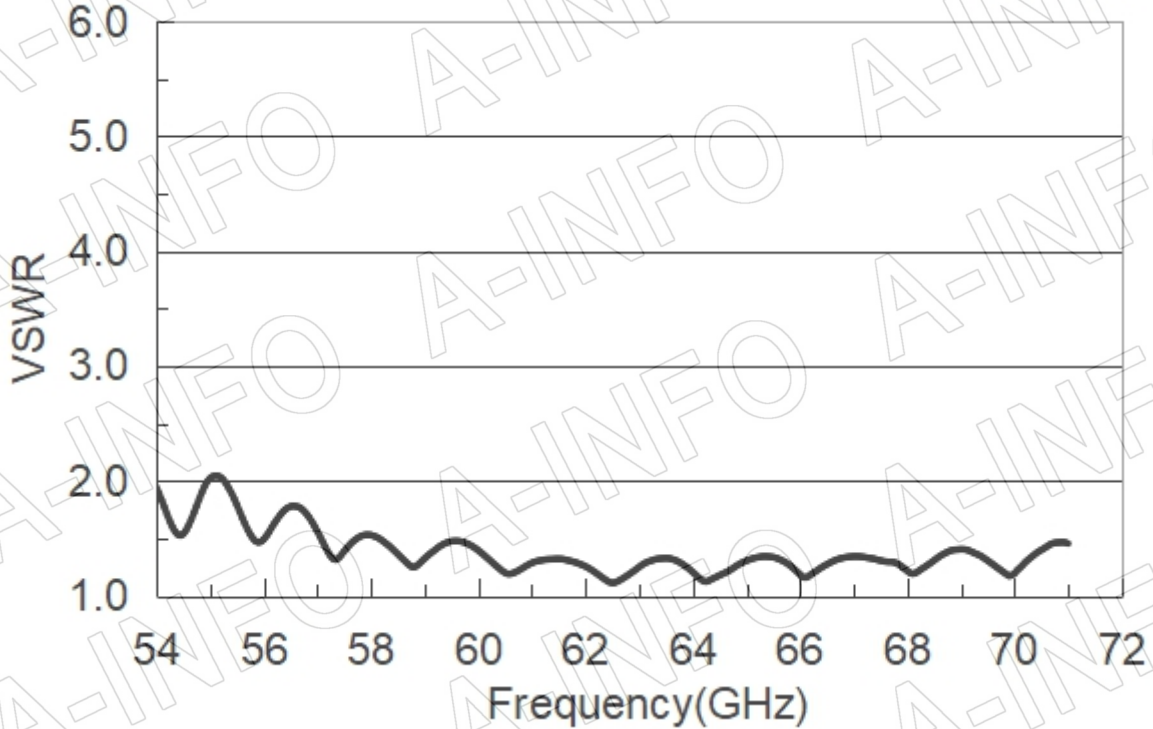

5. Pattern

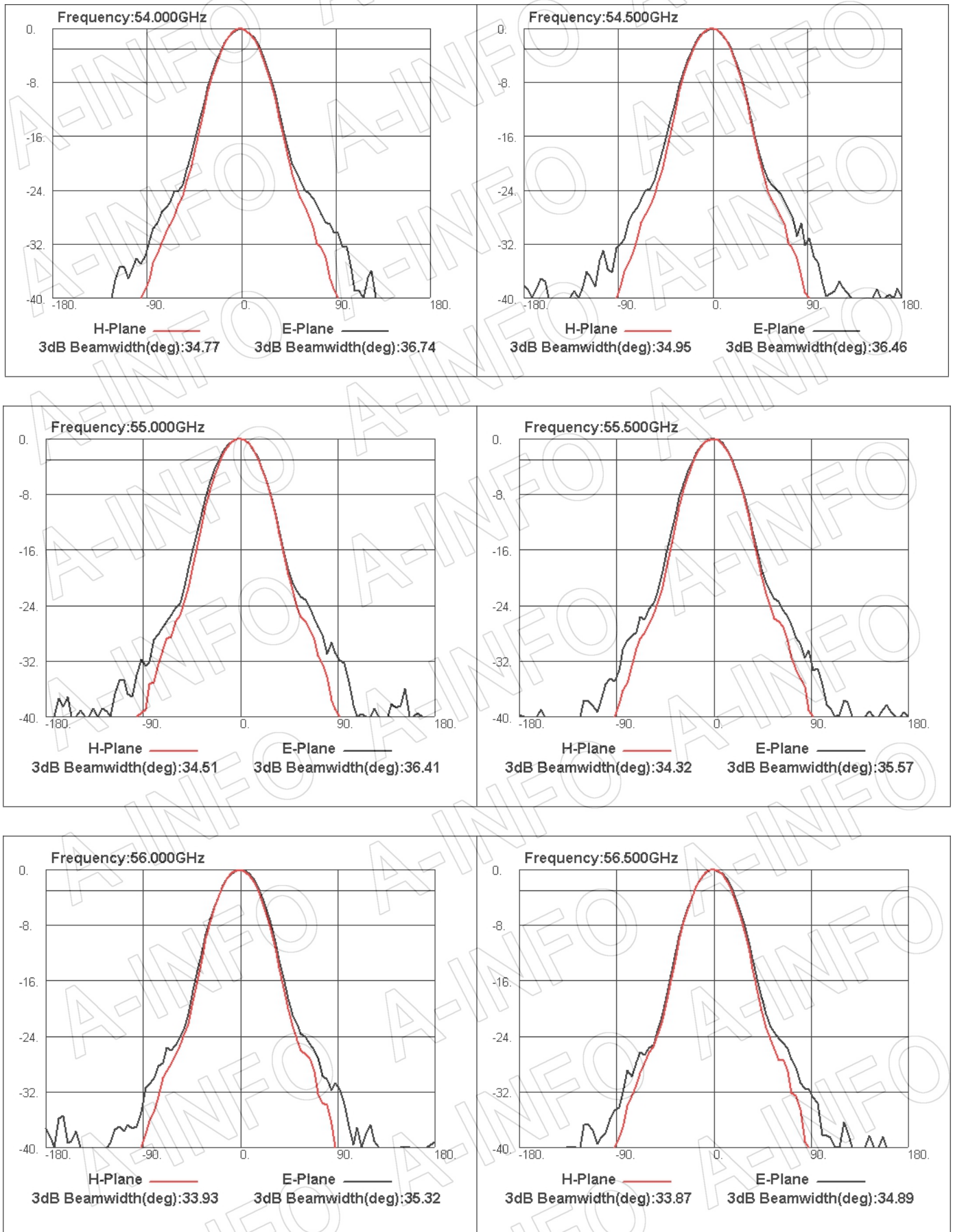

AINFO Inc.

China(Beijing): Tel: (+86) 10-6266-7326,
China(Chengdu): Tel: (+86) 28-8519-2786,
USA: Tel: (+1) 949-639-9688,

Page 8 of 13

(+86) 10-6266-7327 Fax: (+86) 10-6266-7379
(+86) 28-8519-3044 Fax: (+86) 28-8519-3068
(+1) 949-639-9608 Fax: (+1) 949-639-9670

Website: www.ainfoinc.com
Email: sales@ainfoinc.com

